

motor brush holder

FOR BOSCH

For Bosch Starters

OE NO.:1 004 336 245

Brush size: 5x12x11.5 mm



For Bosch Starters

OE NO.:1004 336 518

Brush size: 6x18x14.5 mm



For Bosch Starters

OE NO.:1 004 336 820

Brush size: 5x12x11.5 mm



For Bosch Starters

OE NO.:2 005 855 365

Brush size: 12x36x27 mm



For Bosch Starters

OE NO.:1 004 336 963

Brush size: 5x12x11.5 mm

BRUSH SIZE: 5X12X11.5 mm



**For Bosch Starters
OE NO.:1 004 336 531
Brush size: 5x16x13.5 mm**



**For Bosch Starters
OE NO.:1 004 336 200
Brush size: 5x12x11.5mm**





For Bosch Starters
OE NO.:1 004 336 996
Brush size: 6x18x14.5 mm



For Bosch Starters
OE NO.:1 004 336 915
Brush size: 5x12x11.5 mm



For Bosch Starters

OE NO.:1 004 336 811

Brush size: 5x16x13 mm

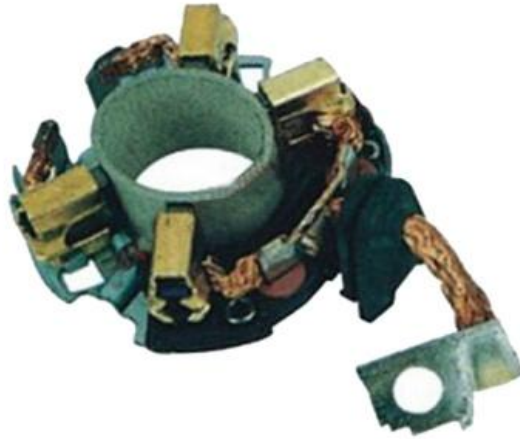

For bosch er/ef Alternators

WAI:39-9100

Brush size:5×8×18mm

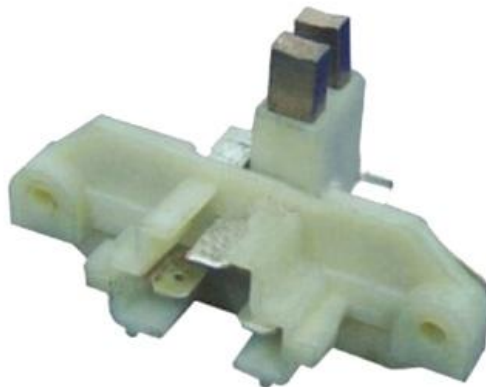

For BOSCH 90-100A ER/EF Alternators

WAI:39-9102

Bush size:4.8x17x16mm





For Bosch 368 DD Starters

WAI:69-9100

Brush size: 8x25x17mm



For Bosch PMGR Starters

WAI:69-9116

Brush size: 5x12x11.5mm





For Bosch 312, 317 Series DD Starters

WAI:69-9114

Brush size: 7x16x15mm



For Bosch PMGR Starters

WAI:69-9121

Brush size: 5x12x11.5 mm



For Bosch 208 Series DD Starters

WAI:69-9117

Brush size: 7x10x14mm



For Bosch Brazilian DD Starters

WAI:69-9110

Brush size: 10x22x22.5mm



For Bosch 110 Series PMGR Starters

WAI:69-9115

Brush size: 6x18x14.5 mm





For Bosch 362,366 DD Starters

WAI:69-9105

Brush size: 9x16x17mm



For Bosch 358,259 DD Starters

WAI:69-9102

Brush size: 10x25x23mm





For Bosch 420 Series DD Starters

WAI:69-9109

Brush size: 10x36x28mm

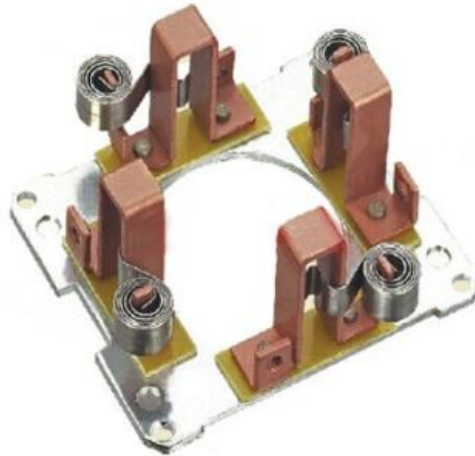

For Bosch 110 Series PMGR Starters

WAI:69-9113

Brush size: 6x18x14.5mm



For Bosch PMGR Starters

WAI:69-9125

Brush size: 5x16x13 mm



For Bosch 218 Series PLGR Starters

WAI:69-9118

Brush size: 7.5x18x18.5mm



For Bosch 367 DD Starters

WAI:69-9106

Brush size: 10x25x15mm





For Bosch 108 Series PMGR Starters

WAI:69-9111

Brush size: 5x16x13mm



FOR DELCO

For :Delco 10DN Series ER/EF Alternators

Model NO.: 39-100-3

Brush size: 5x18x13.2mm



For :Delco 10SI, 12SI, 27SI/Type 100 Series IR/EF Alternators

Model NO.: 39-101-3

Brush size: 5x8x12.8mm

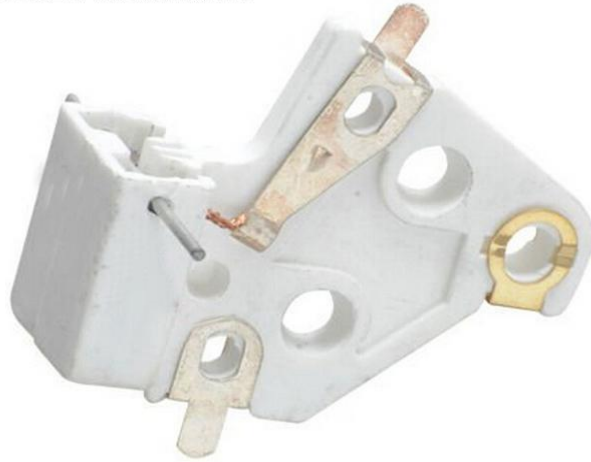

For :Delco 15SI/Type 116, 19SI, 21SI Series IR/EF Alternators

Model NO.: 39-104-3

Brush size: 5x6x22mm



For :Delco 27SI/Type 200 Series IR/EF Alternators

Model NO.: 39-105

Brush size: 5.2x8.3x20.5mm



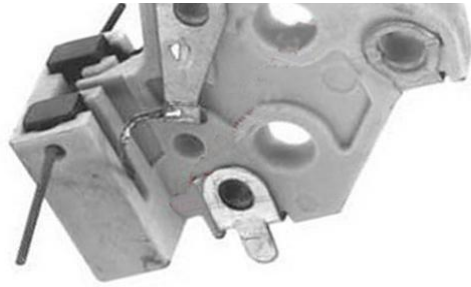

For :Delco CS121D Series IR/IF Alternators

Model NO.: 39-111

Brush size: 5x8x22.5mm



For :Delco 28MT Series OSGR Starters

Model NO.: 69-8400

Brush size:8×25×20mm

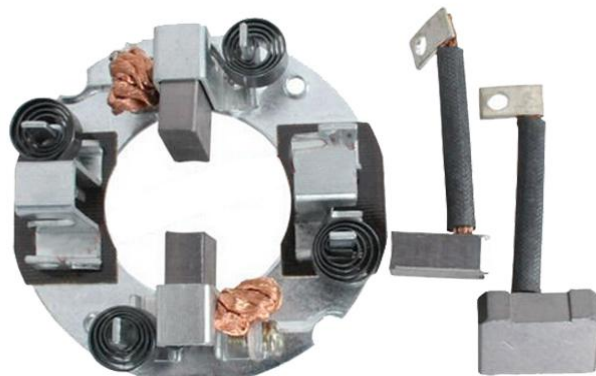

For :Delco 39MT Series PLGR Starters

Model NO.: 69-125

Brush size:9.5x32x22.5mm



For :Delco 29MT Series PLGR Starters

Model NO.: 69-128

Brush size:8x25x20mm

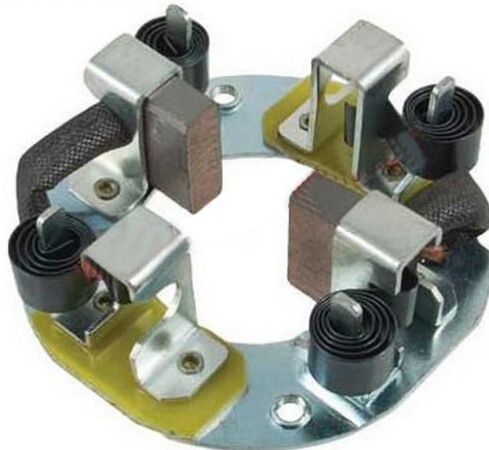

For :Delco 37MT Series DD Starters

Model NO.: 69-105-3

Brush size: 9.5x28.5x24mm

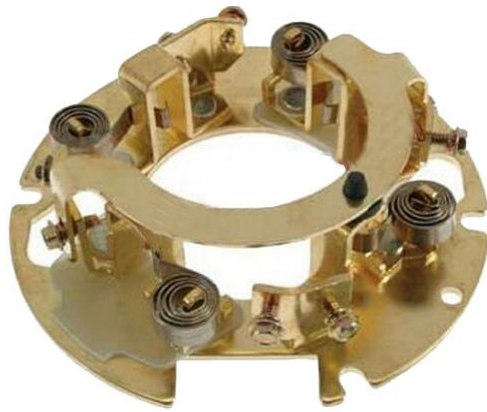

For :Delco PG260D Series PMGR Starters

Model NO.: 69-127

Brush size:5x15x12.5mm



For :Delco PG260M Series PMGR Starters

Model NO.: 69-114-1

Brush size:6x19x16mm





For :Delco 37MT, 41MT Series DD Starters

Model NO.: 69-111

Brush size: 9.5x28.5x24mm

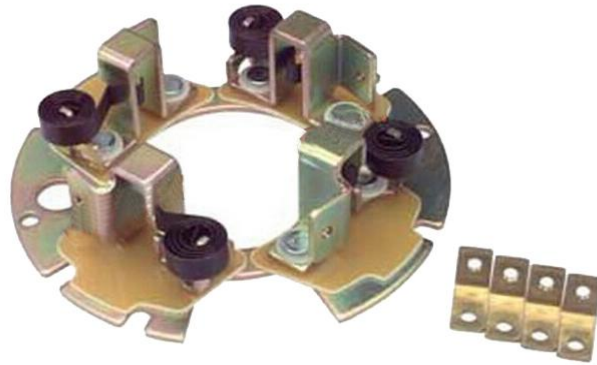

For :Delco PG260F2 Series PMGR Starters

Model NO.: 69-118

Brush size: 5x18x15mm



For :Delco PG260D Series PMGR Starters

Model NO.: 69-119

Brush size: 5x15x12.5mm



For :Delco PG260G Series PMGR Starters

Model NO.: 69-120

Brush size: 5x16x12.5mm



For :Delco 21SI, 22SI Series IR/EF Alternators

Model NO.: 39-110

Brush size: 5.5x8x40mm





For :Delco AD230, AD237, AD244 Series IR/IF Alternators

Model NO.: 39-112

Brush size: 4.5x8x23mm



For :Delco PG260F2 Series PMGR Starters

Model NO.: 69-117

Brush size: 5x18x15mm



For :Delco 50MT Series DD Starters

Model NO.: 69-115-1

Brush size: 8x38x19.5mm

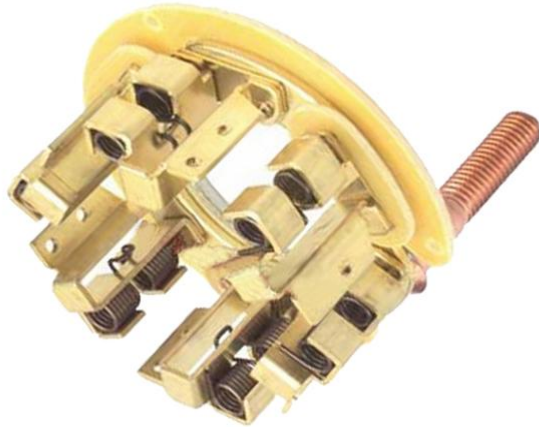

**For :Delco PG150, PG150S, PG260F1, PG260G Series
PMGR Starters**

Model NO.: 69-113-1

Brush size:5x16x12.5mm

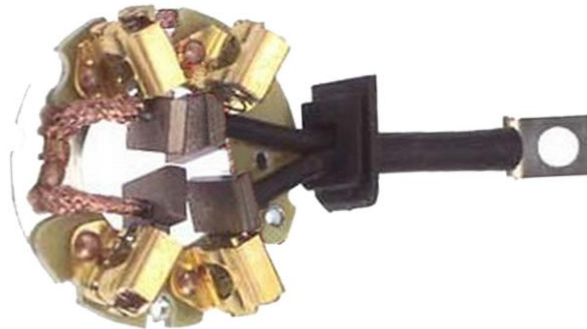

For :Delco 40MT Series DD Starters

Model NO.: 69-102-1

Brush size: 9.5x38x19.5mm





For :Delco 42MT Series DD Starters

Model NO.: 69-103-3

Brush size: 10.5x36.5x24.4mm

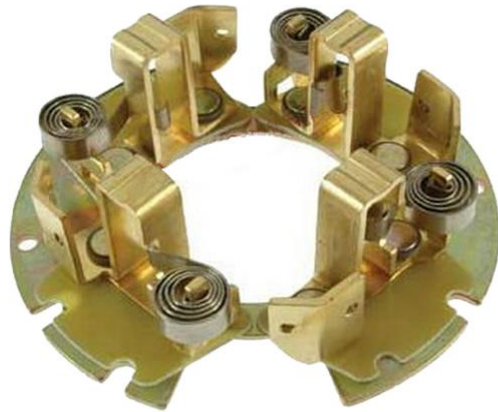

For :Delco 40MT Series DD Starters

Model NO.: 69-101

Brush size: 9.5x19x19mm

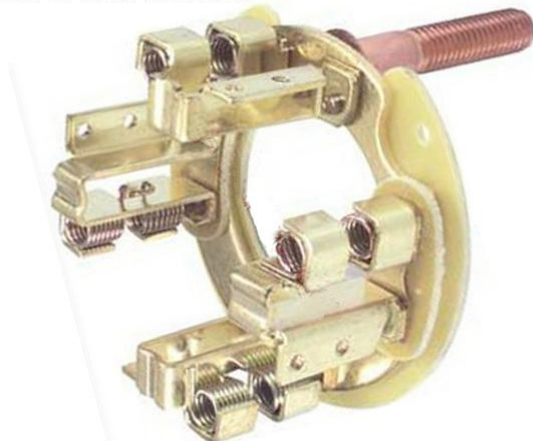

For :Delco 50MT Series DD Starters

Model NO.: 69-104

Brush size:8x19x19mm



For :Delco PG200, PG250 Series PMGR Starters

Model NO.: 69-107

Brush size: 7x22x15mm



For :Delco SD205, SD210, SD255, SD260 Series DD Starters

Model NO.: 69-109

Brush size: 6.5x14.5x14.5mm



For :Delco 5MT, SD200, SD250 Series DD Starters

Model NO.: 69-106

Brush size:6.5x16x14mm

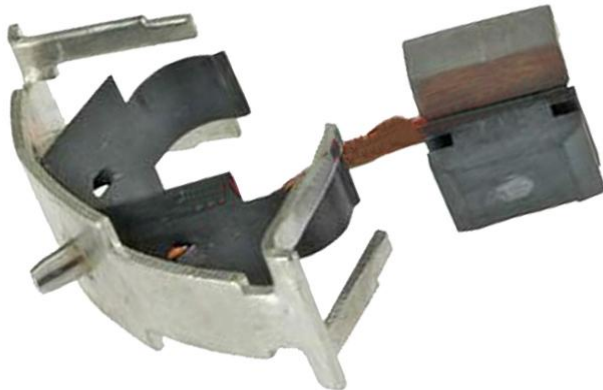

For :Delco 35MT Series, External Rotatable DD Starters

Model NO.: 69-116

Brush size: 10x20x18mm





For :Delco 42MT Series DD Starters

Model NO.: 69-103

Brush size: 10.5x36.6x24.4mm



**For :Delco PG150, PG150S, PG260F1, PG260G Series
PMGR Starters**

Model NO.: 69-113

Brush size: 5x16x12.5mm



For :Delco 37MT, 41MT Series DD Starters

Model NO.: 69-108

Brush size:9.5x28.5x24mm

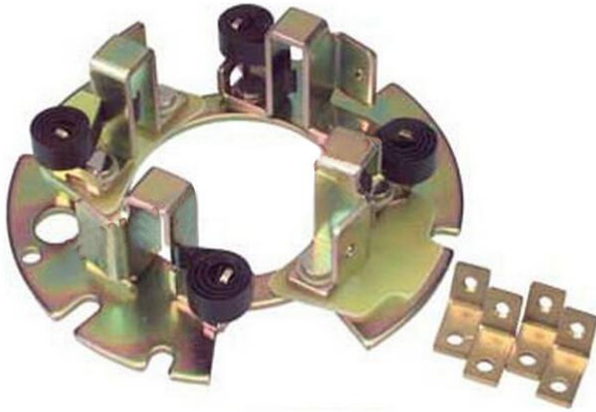

For :Delco PG260G Series PMGR Starters

Model NO.: 69-122

Brush size:5x16x12.5mm



For :Delco PG260L Series PMGR Starter

Model NO.: 69-121

Brush size: 5x18x14.5mm





For :Delco 5MT, SD200, SD250 Series DD Starters
Model NO.: 69-1200

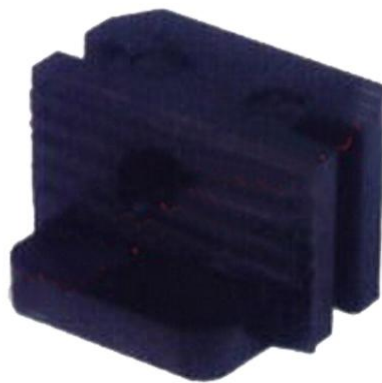

FOR DENSO

For :Nippondenso IR/IF Alternators
Model NO.: 39-8200
Brush size: 5×7×15 mm





For :Nippondenso 75, 90A ER/IF Alternators

Model NO.: 39-8201

Brush size: 5×7×15 mm

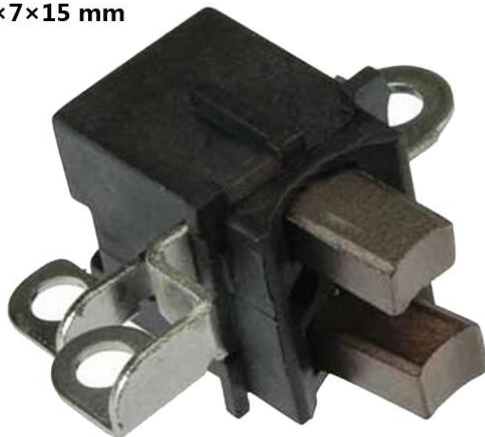

For :Nippondenso 90-120A ER/IF Alternators

Model NO.: 39-8202

Brush size: 5×7×15 mm



For :Nippondenso IR/IF Alternators

Model NO.: 39-8203-3

Brush size: 5×7×15 mm



For :Nippondenso 120-160A ER/IF, IR/IF Alternators

Model NO.: 39-8207

Brush size: 5×7×15 mm



**For :Nippondenso 1.0kW, 1.4kW Early OSGR Starters w
/ Internal Thru Bolts**

Model NO.: 69-8200

Brush size: 7x16x15.5





**For :Nippondenso 1.4kW, 1.6kW OSGR Starters w
Model NO.: 69-8201
Brush size: 7x16x15.5mm**



**For :Nippondenso 2.0kW OSGR Starters
Model NO.: 69-8202
Brush size: 8x25x15.5mm**



**For :Nippondenso 1.2kW OSGR Starters w/
Cast Aluminum C.E. Frame & 45mm Field Case Length**

Model NO.: 69-8207-2

Brush size:6.5x13x13.5mm



For :Nippondenso 3.0kW, 5.5kW OSGR Starters

Model NO.: 69-8208

Brush size:10x30x25mm



For :Nippondenso 2.5kW, 4.5kW OSGR Starters

Model NO.: 69-8203

Brush size:7.8x24.8x21mm





**For :Nippondenso 1.0kW, 1.2kW OSGR Starters w
/ Stamped Steel C.E. Frame
Model NO.: 69-8206-2
Brush size:7x16x15.5mm**

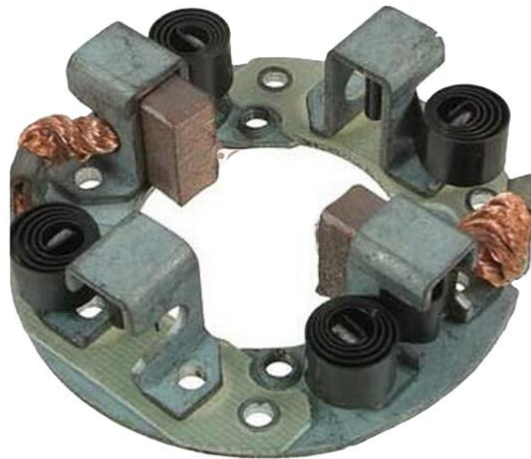

FOR FORD

**For :Ford 1G Series 40-65A ER/EF Alternators
WAI NO.:39-200
Brush size:5x6.5x12.5mm**

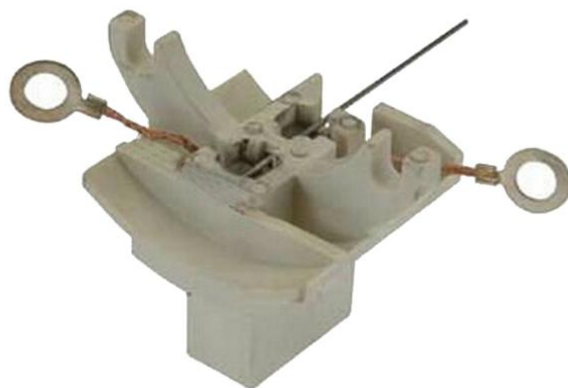

For :Ford 1G Series 70-100A ER/EF Alternators
WAI NO.:39-201
Brush size:4x7.5x12.5mm



For :Ford 2G Series IR/EF Alternators
WAI NO.:39-202
Brush size:4x7.5x12mm

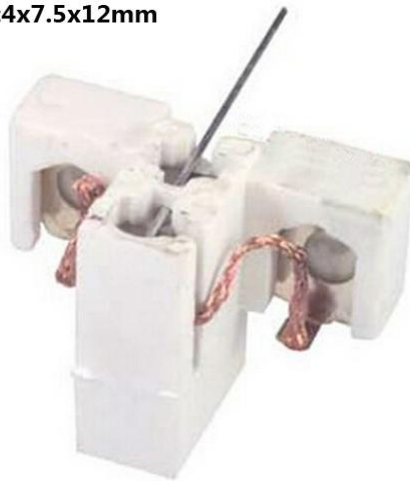

For :Ford 3G Series IR/IF Alternators
WAI NO.:39-207
Brush size: 4x7.5x18mm





For :Ford 3G Series IR/IF Alternators

WAI NO.:39-207-1

Brush size: 4x7.5x18mm

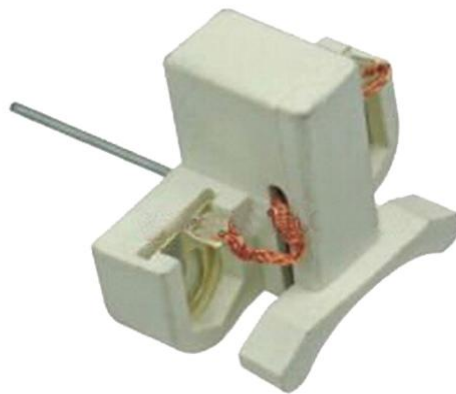

For :Ford PMGR Starters

WAI NO.:69-201

Brush size: 4.5*16*14mm



For :Ford PMGR Noseless Starters

Model NO.: 69-202

Brush size:***





For :Ford 3.0-3.5kW OSGR Starters

Model NO.: 69-203

Brush size:8.3x19x18



For :Ford PMGR External Thru Bolt Starters

Model NO.: 69-204

Brush size: 6x13x14.2mm

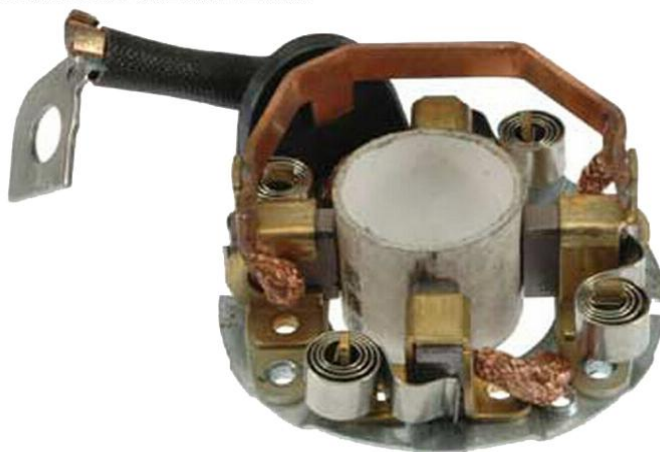

For :Ford Starter
OE NO.: E9OZ 11061 A
Brush size: 4.5x16x14 mm



For :Ford 4 in. Mod II DD Starters
Model NO.: 69-2202
Brush size: 8.3x19x10mm



For :Ford 4 in. Mod II DD Starters
Model NO.: 69-2204
Brush size: 8.5x19x10 mm



FOR HITACHI

For :Hitachi IR/EF Alternators w/ Vacuum Pump

Model NO.: 39-8105

Brush size: 5x8x21mm



For :Hitachi IR/IF Alternators

Model NO.: 39-8108

Brush size: 5x8x26mm



For :Hitachi IR/IF Alternators

Model NO.: 39-8112

Brush size: 5x8x26.5mm





For :Hitachi IR/IF Alternators

Model NO.: 39-8114

Brush size: 5x8x26mm



For :Hitachi IR/IF Alternators

Model NO.: 39-8116

Brush size: 5x8x26mm



For :Hitachi IR/IF Alternators

Model NO.: 39-8118

Brush size: 5x8x26mm

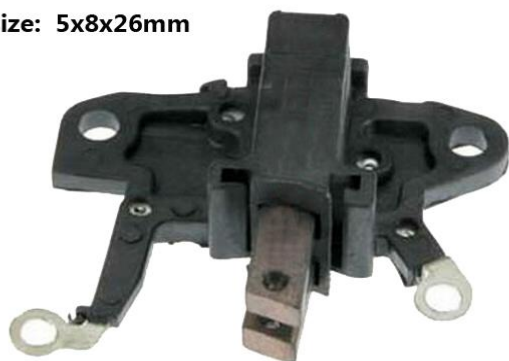

For :Hitachi OSGR Starters

Model NO.: 69-8101

Brush size: 7x14x15.5mm

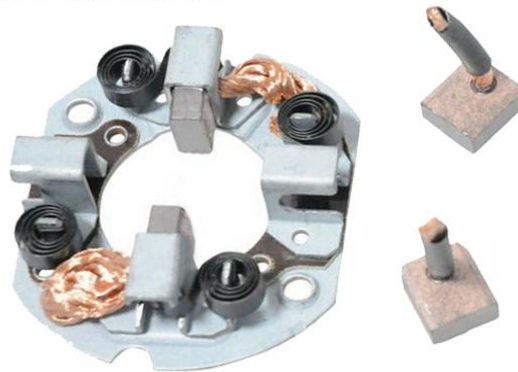

For :Hitachi DD Starters

Model NO.: 69-8104

Brush size: 7x11x16mm

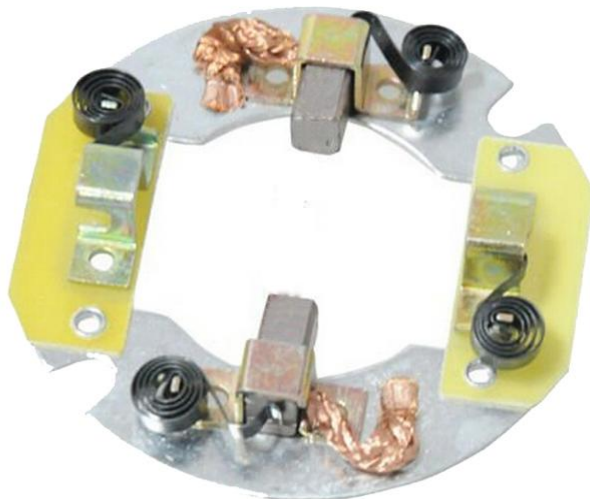

For :Hitachi DD, OSGR Starters

Model NO.: 69-8105

Brush size: 7x11x16.5mm



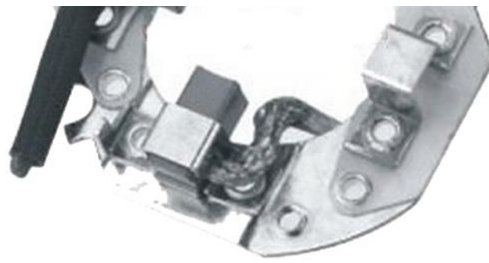

For :Hitachi OSGR Starters
Model NO.: 69-8113
Brush size: 7x19x16mm

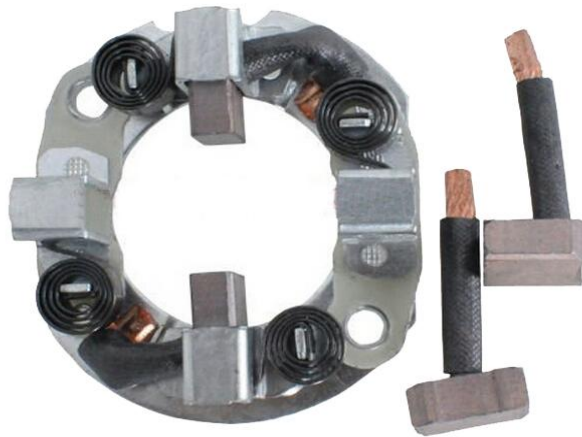

For :Hitachi PMGR Starters
Model NO.: 69-8115
Brush size: 7x11x16.5mm



For :Hitachi PMGR Starters
Model NO.: 69-8117
Brush size: 4.4x14x14.5mm





For :Hitachi PMGR Starters
Model NO.: 69-8118
Brush size: 4.4x14x14.5mm



FOR MITSUBISHI

For :Mitsubishi ER/IF Alternators
Model NO.: 39-8300
Brush size: 5x8x23mm

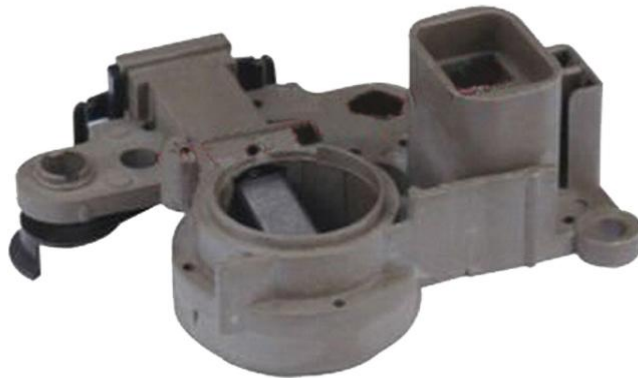

For :Mitsubishi ER/IF Alternators
Model NO.: 39-8301
Brush size: 5x8x23mm





For :Mitsubishi OSGR Starters
Model NO.: 69-8300
Brush size:8x24x18mm



For :Mitsubishi OSGR Starters
Model NO.: 69-8301
Brush size:8x24x18mm



For :Mitsubishi OSGR Starters

Model NO.: 69-8302

Brush size:6.5x18x18mm

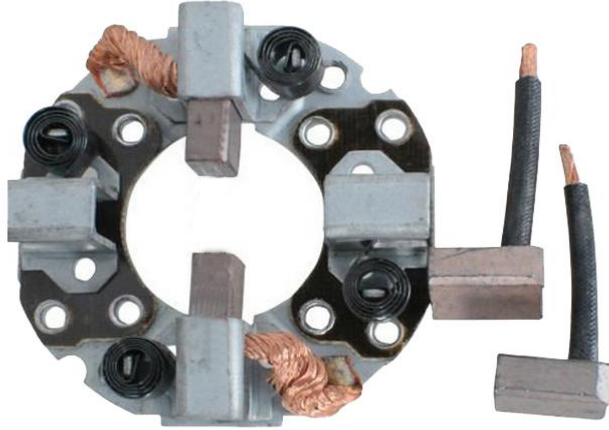

For :Mitsubishi DD, OSGR Starters

Model NO.: 69-8306

Brush size: 6.8x12x16.5mm



For :Mando, Mitsubishi PMGR Starters

Model NO.: 69-8308

Brush size: 4.5x11.8x17.5mm



For :Mando. Mitsubishi PMGR Starters

For :Mitsubishi PMGR Starters

Model NO.: 69-8308-1

Brush size: 4.5x11.8x17.5mm



For :Mitsubishi PMGR Starters

Model NO.: 69-8309

Brush size: 4.5x18x17.5mm



For :Mitsubishi OSGR Starters

Model NO.: 69-8311

Brush size: 7x12x16mm



For :Mitsubishi PMGR Starters

For :Mitsubishi PLGR Starters

Model NO.: 69-8312

Brush size: 8x24x18mm

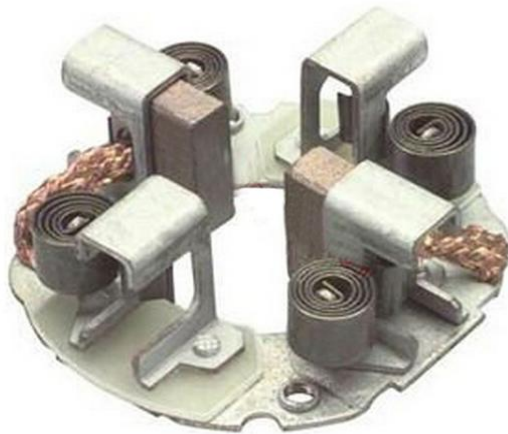

For :Mitsubishi PMGR Starters

Model NO.: 69-8313

Brush size: 4.5x12x12mm



For :Mando, Mitsubishi DD Starters

Model NO.: 69-8315

Brush size: 7x10x16.5mm



For :Mitsubishi PMGR Starters
Model NO.: 69-8317
Brush size: 4.5x12x12mm



For :Mitsubishi PMGR Starters
Model NO.: 69-8318
Brush size: 4.5x12x12mm



For :Mitsubishi PMGR Starters
Model NO.: 69-8322
Brush size: 4.5x12x12mm



For :Mitsubishi PMGR Starters
Model NO.: 69-8323
Brush size: 4.5x12x12mm





For :Mitsubishi Starters
Model NO.: M649X20771
Brush size: 7x12x16.5mm



IF YOU DONNOT FIND THE MODEL YOU WANT,PLEASE FEEL
FREE TO CONTACT US!

washing machine carbon brushes

MOQ:2000PAIRS

5 × 12.5 × 36MM



WS1

5-12.5-36mm

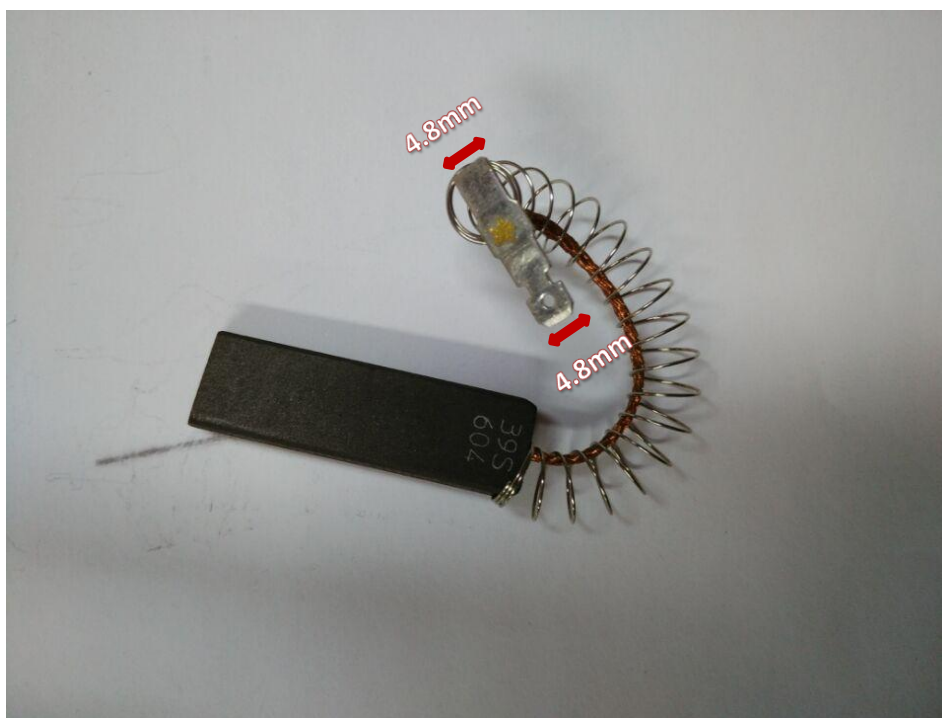

WS2

5-12.5-42mm



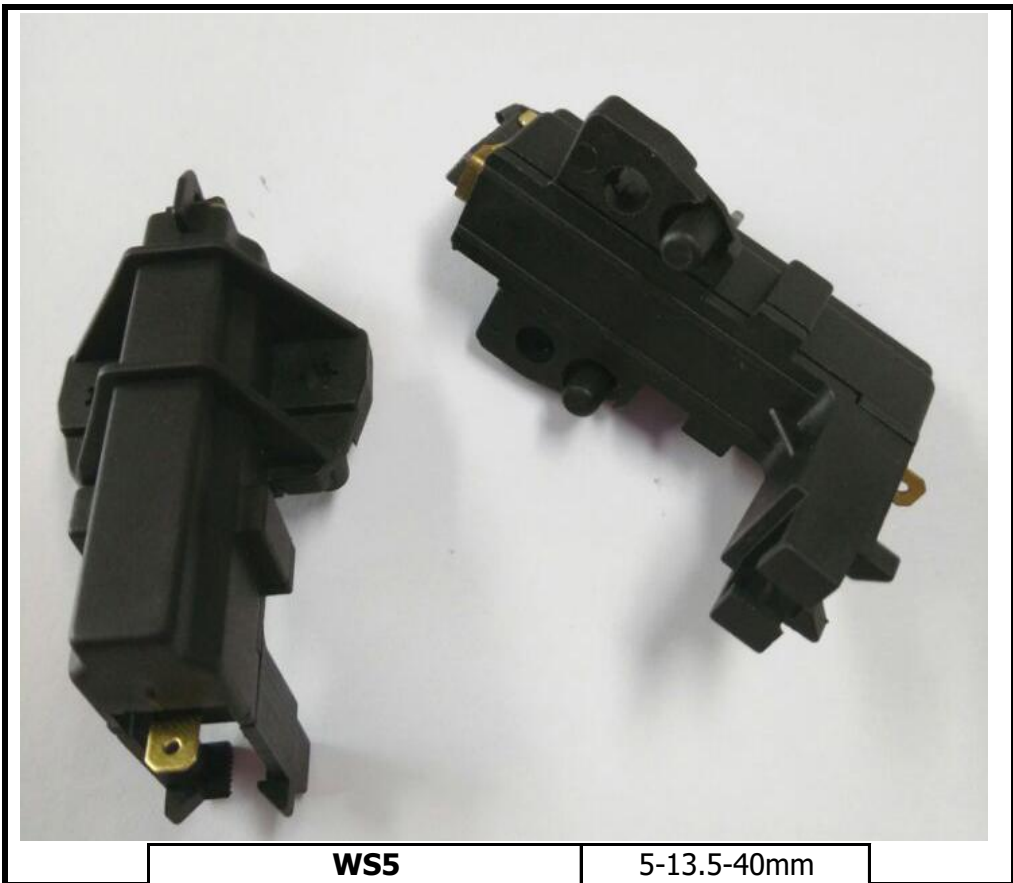

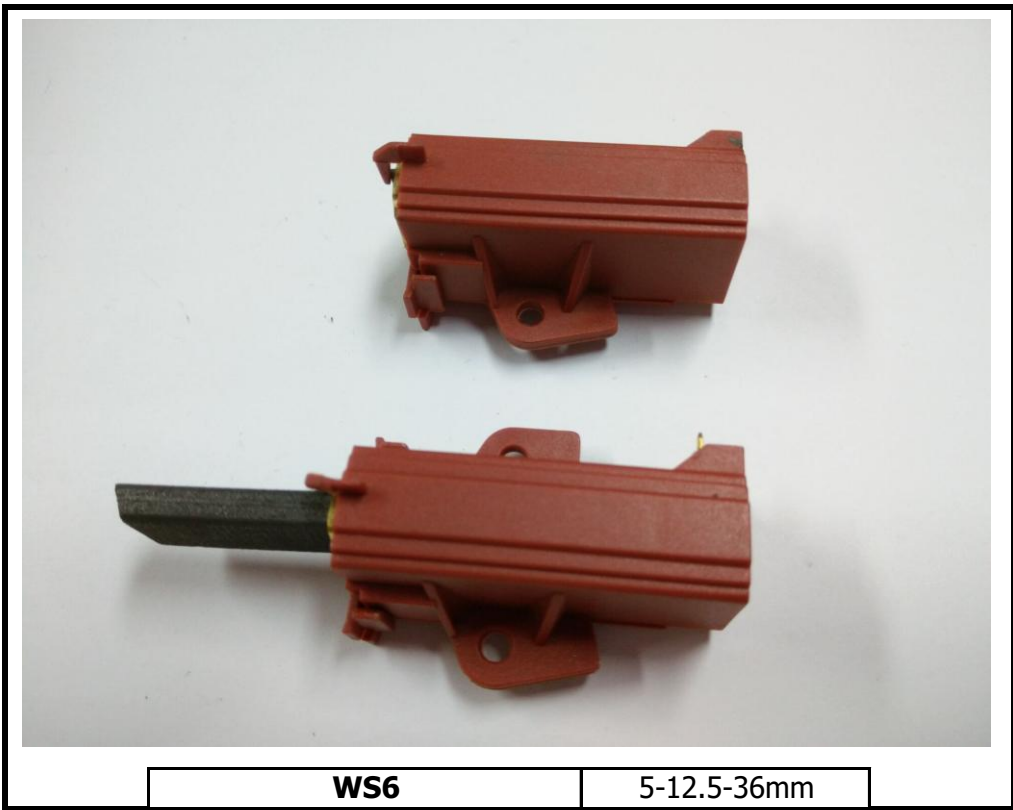

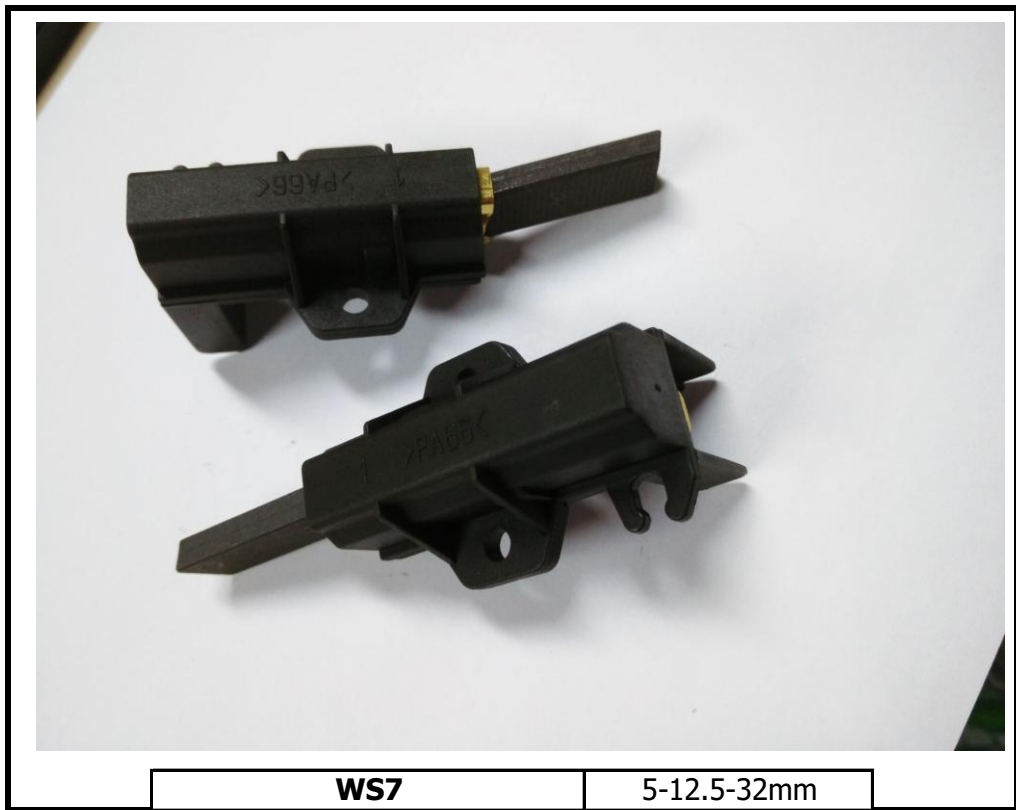



WS7-A (black holder)	5-12.5-32mm
-----------------------------	-------------



WS8	5-13.5-40mm
------------	-------------



WS9

5-12.5-32mm



WS10

5-12.5-36mm



WS10-A

5-12.5-36mm

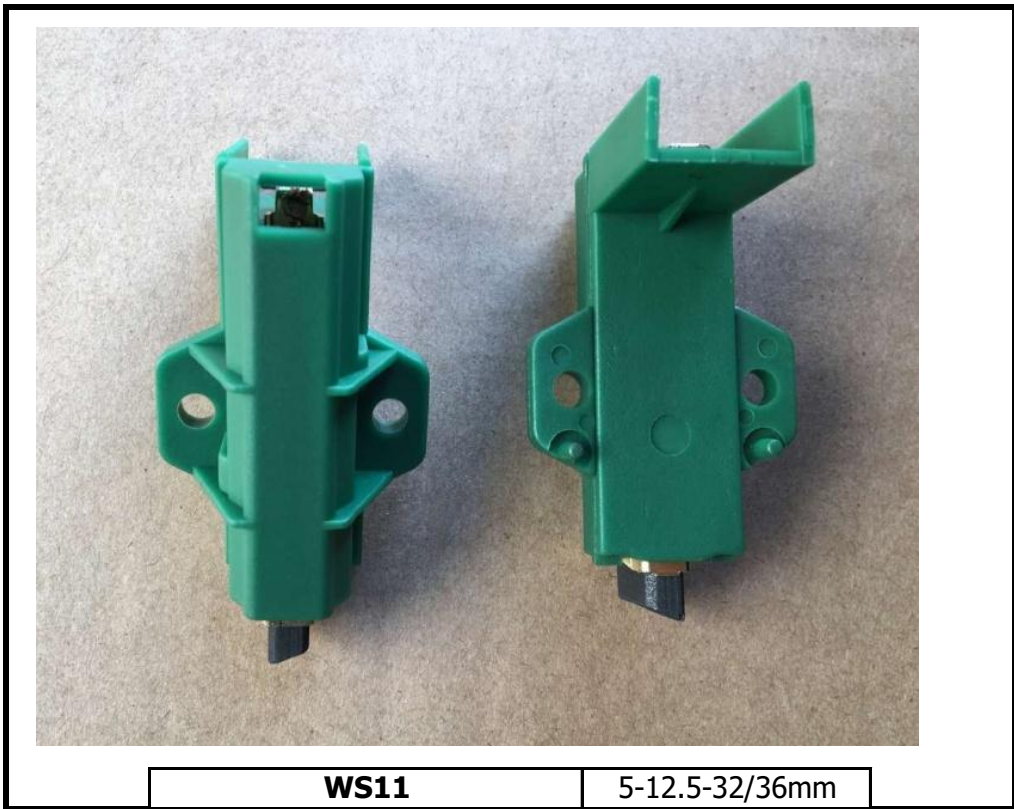

WS11

5-12.5-32/36mm

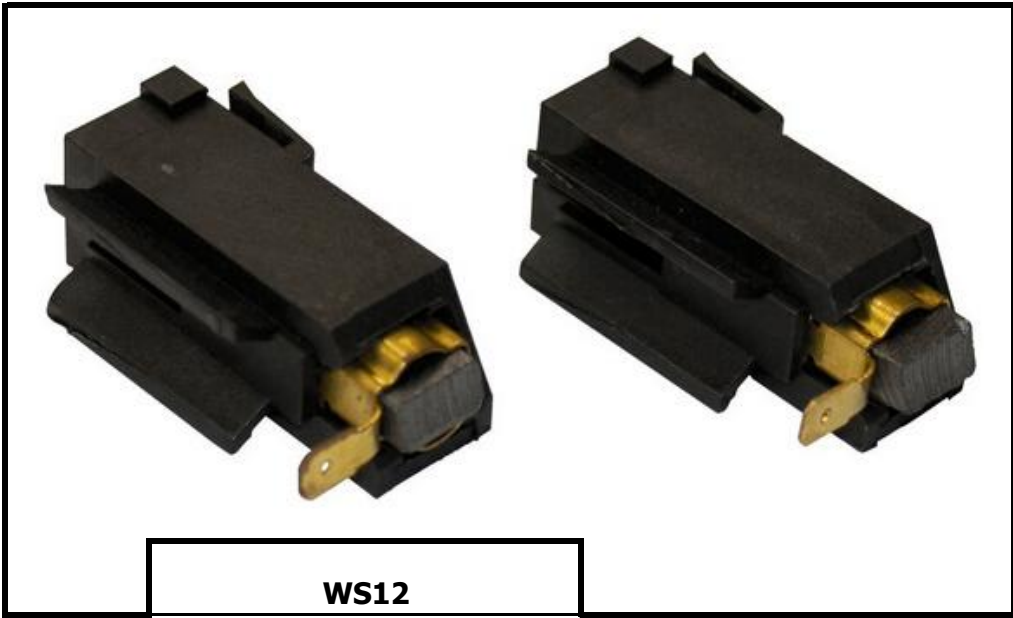

WS12



WS13

5-12.5-36mm



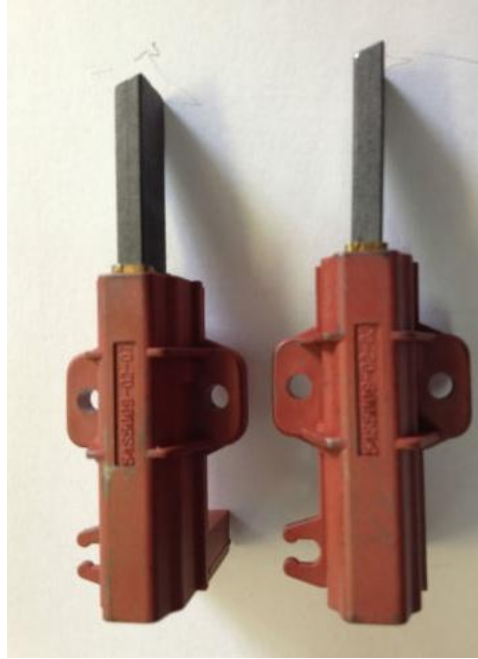

WS15-A

5-13.5-40mm



WS16

5-12.5-40/42mm

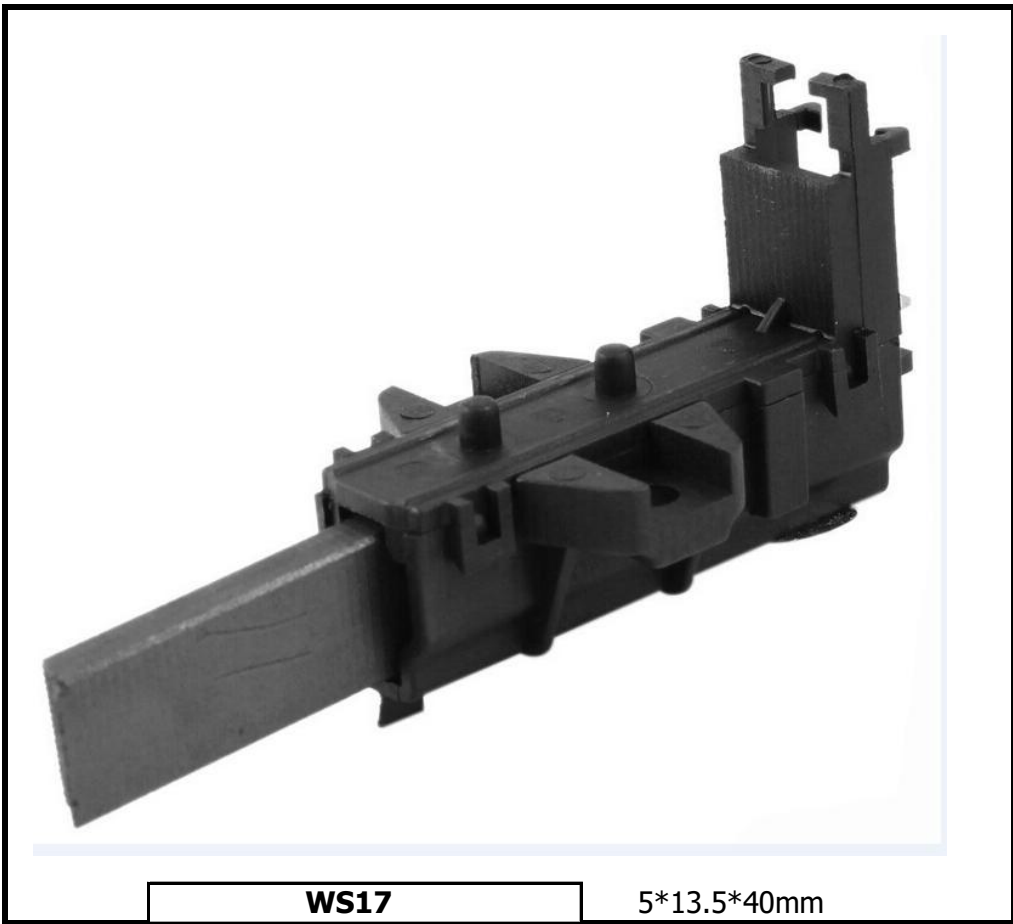

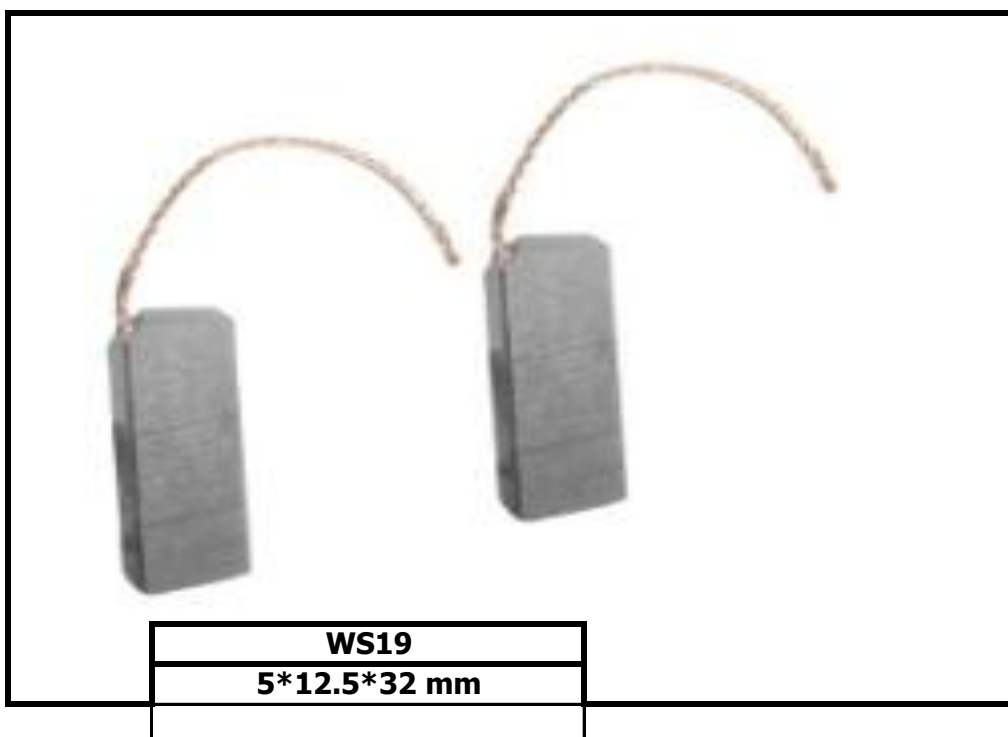

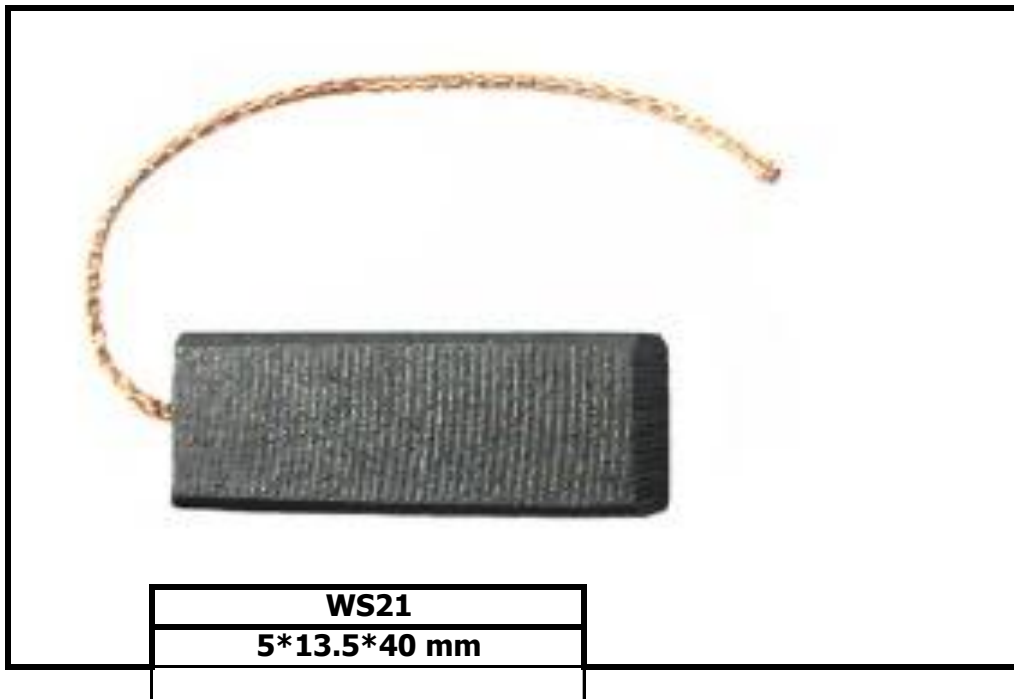

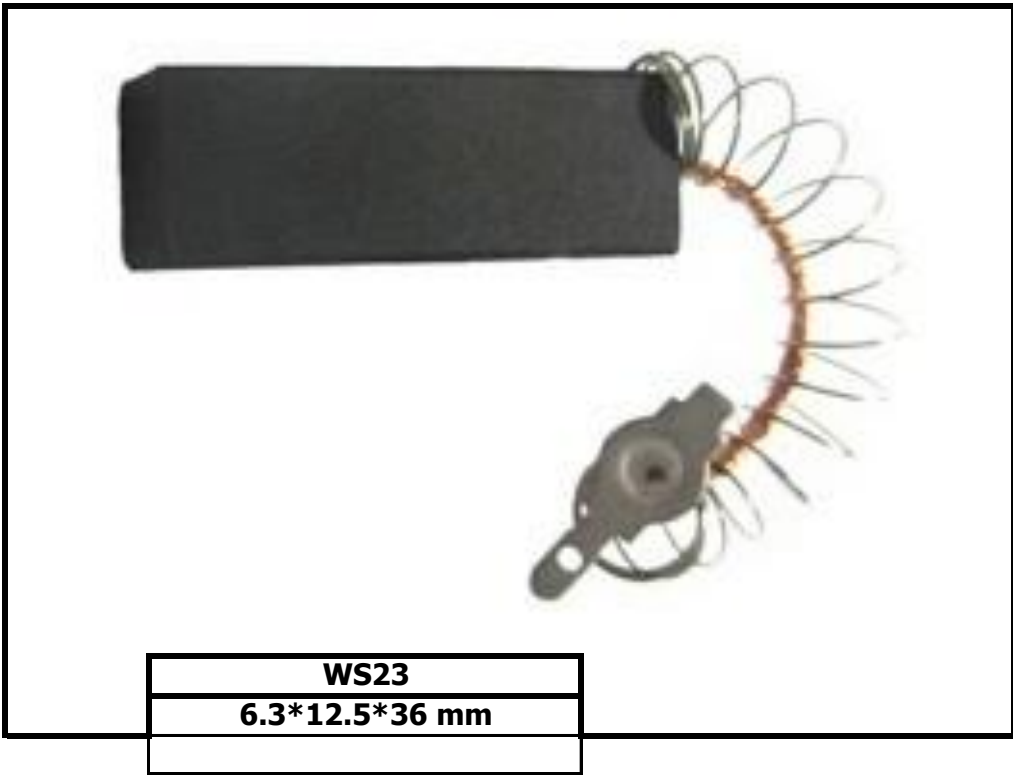



WS24
5-13.5-36mm



WS25

5-12.5-32mm



WS25-A

5-12.5-32mm

carbon brush for vacuum cleaner



VC1
6.2-11-32mm



VC2
size:6.2-11-32mm

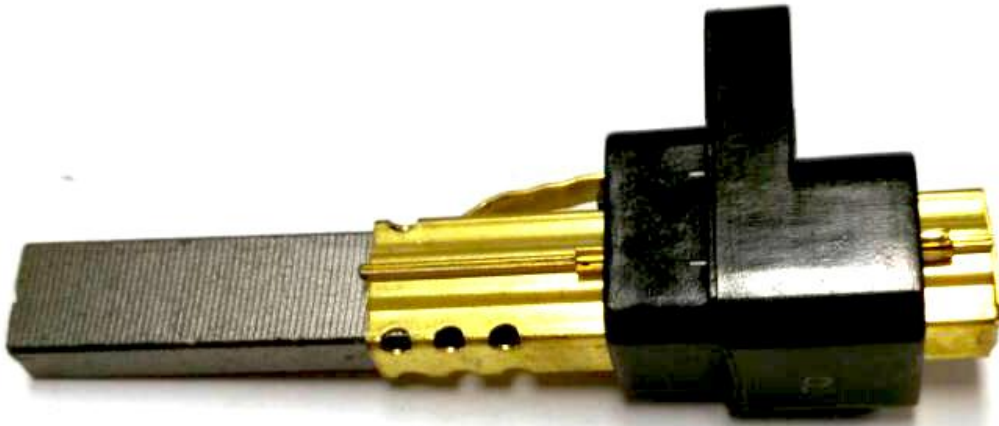

VC3
6.07-10.66-36.30mm

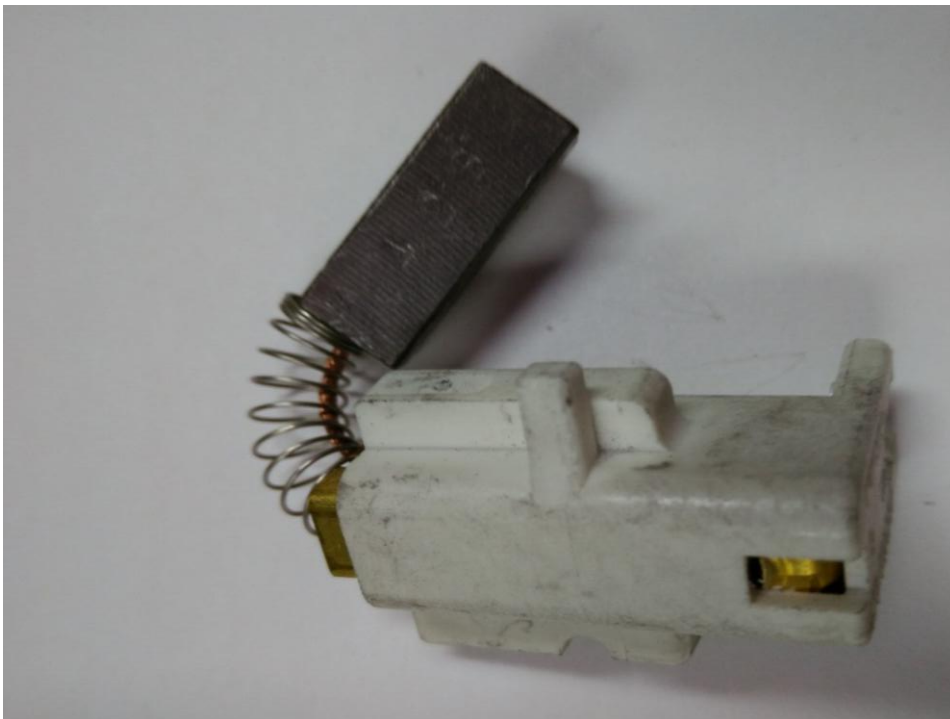

VC4-KIRBY BRUSH
6.02-9.18 -23.68mm